



Pre-commercial procurement in robotics HORIZON 2020 - ICT 27 (d)

Michel Brochard

Programme Officer - EU policies
Unit A1 - Robotics and Artificial Intelligence
DG Communications Networks, Content and Technology
European Commission



Agenda

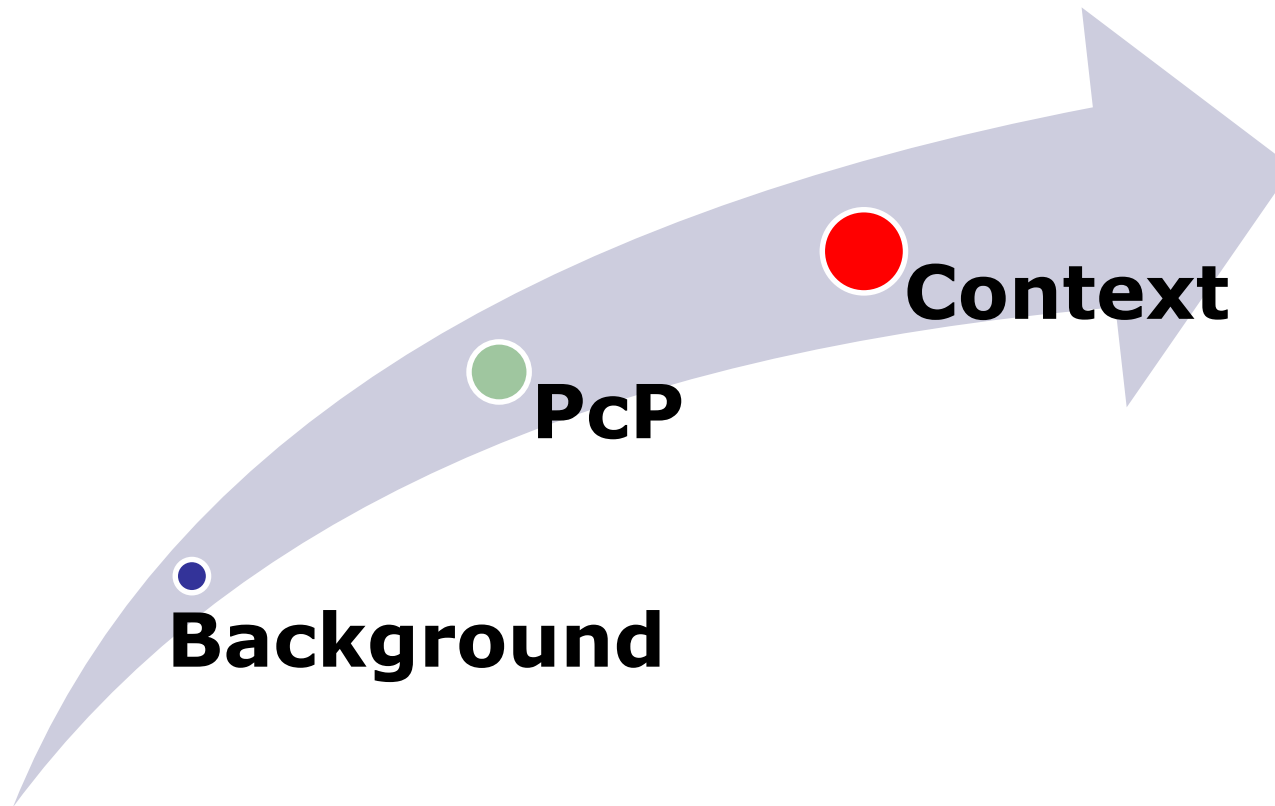

Background

PcP

Context



EU robotics funding

20 P/y

100 P

>700 Pr

€70-80M / y

Results

Community

Critical mass

Not sufficiently Translated to innovative solutions, start-ups and new business ...



H2020 context

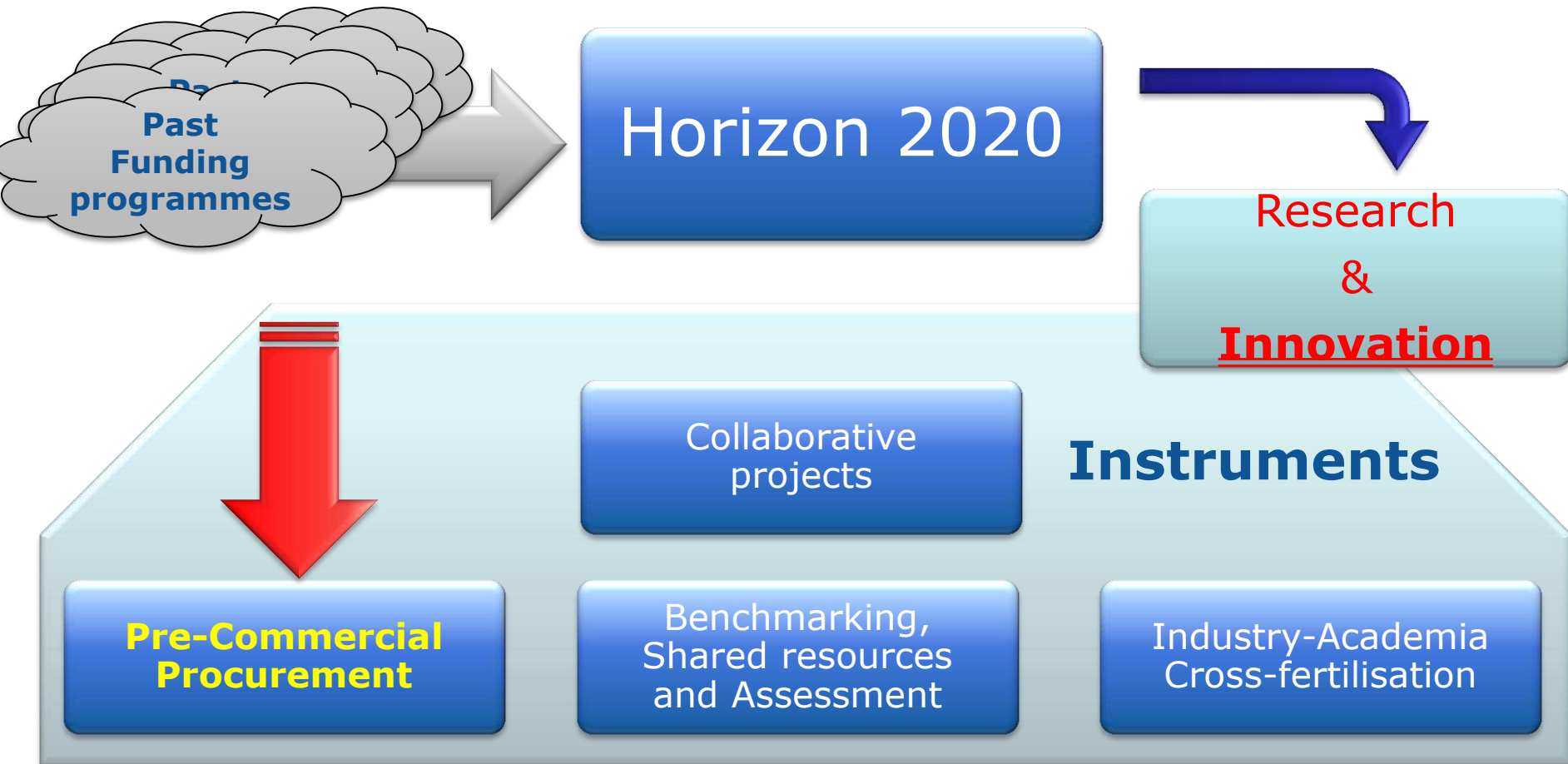



Goal





Conditions

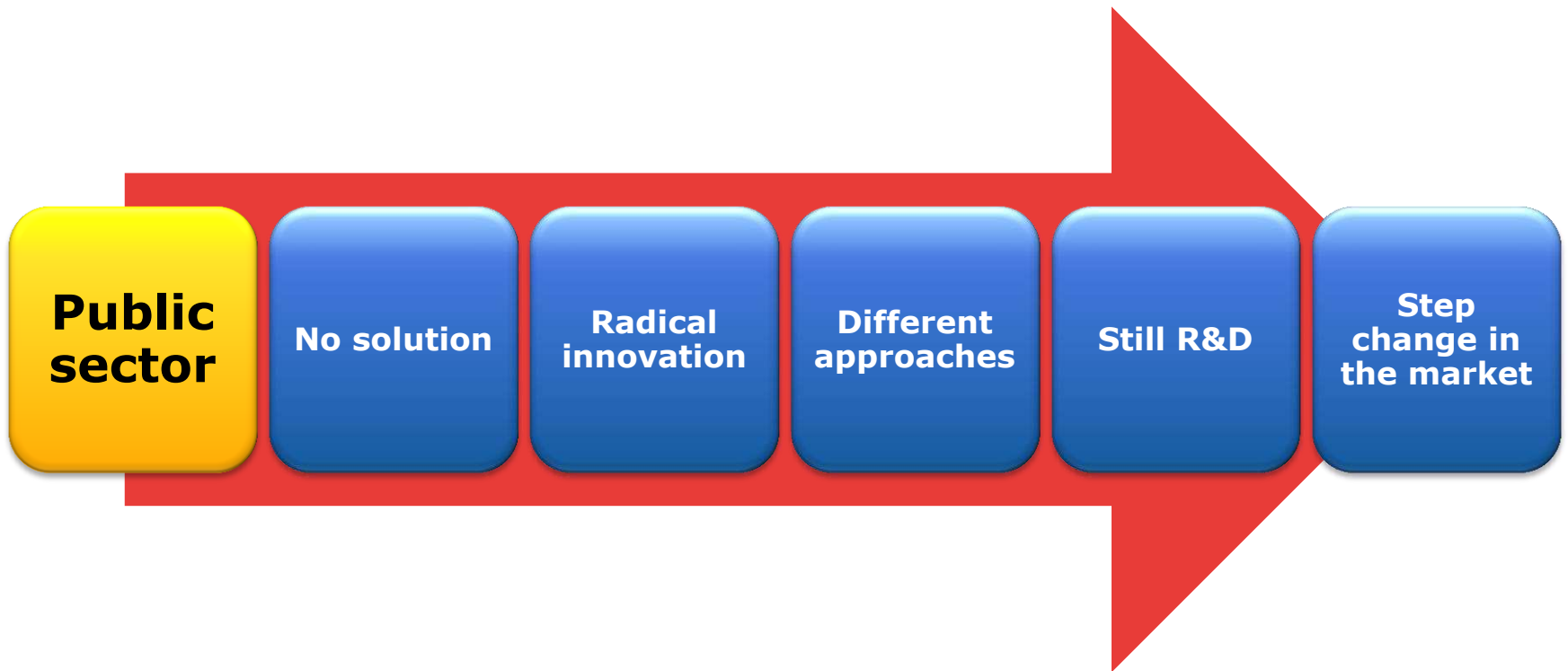



Conditions

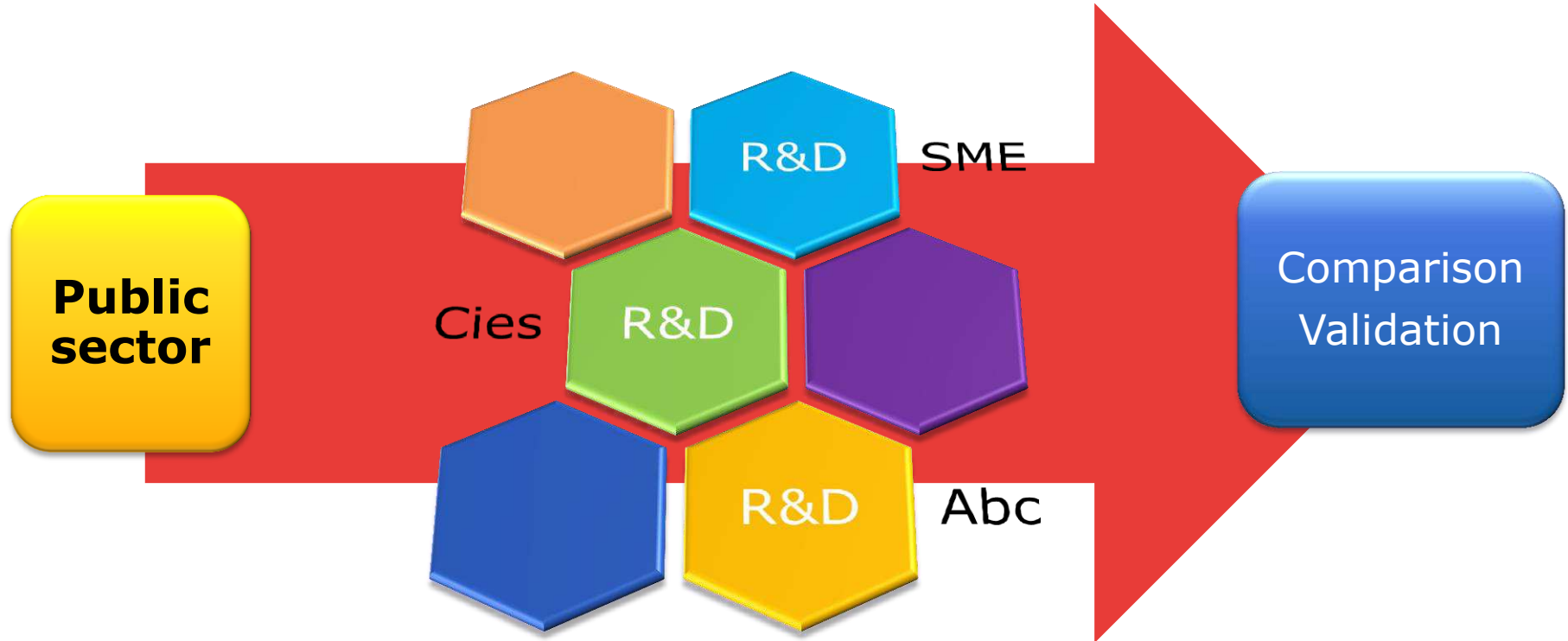



Definition

PCP to steer
the development of **solutions** towards
concrete public sector needs,
whilst comparing/validating
alternative solution approaches
from **various vendors**



Rules

Minimum **3** independent participants
from **3** different MS or AC,

of which minimum **2 public procurers**
(buyers group) from 2 different MS or AC



PcP actions

For an actual PCP procurement

(1 joint PcP procurement/PcP action)

Provide EU co-financing
@
90% funding rate

and

For related coordination and networking activities

e.g. to prepare, manage and follow-up the PCP procurement



In practice

**Public
sector**

*buys R&I from **several suppliers** in parallel*

***evaluates progress** after critical milestones*

***risks & benefits of R&I** (e.g. IPRs) shared with suppliers
to maximise incentives for wide commercialisation*



Different phases

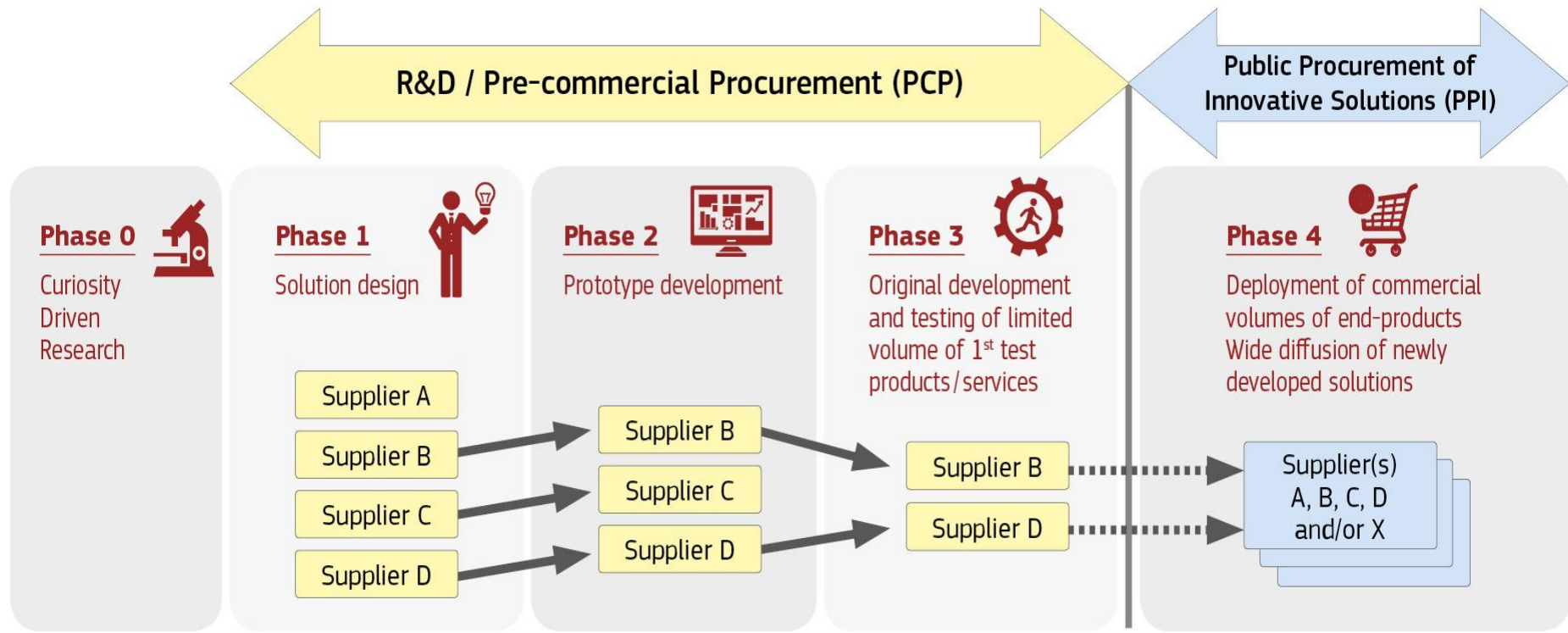



Example: 1. Phases

One Joint PCP Call for Tender +
Joint evaluation offers
(common tender specs)

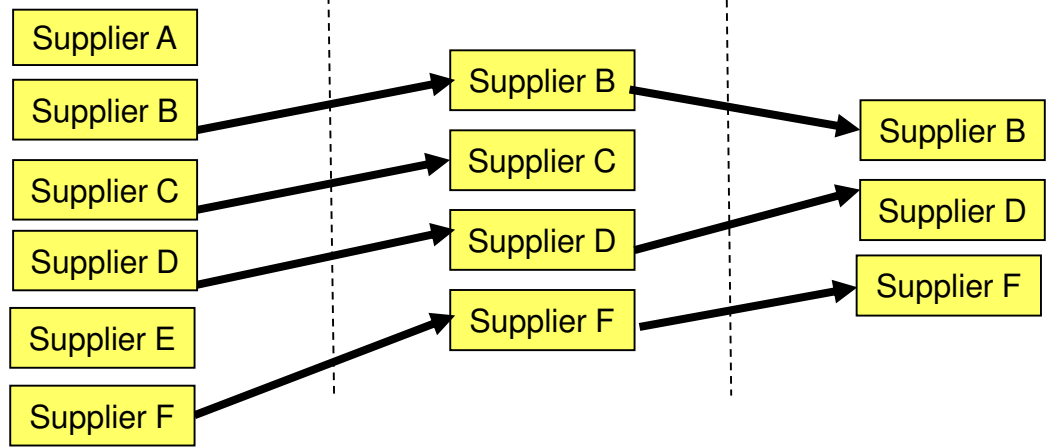
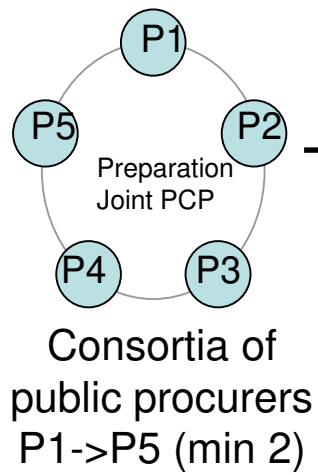
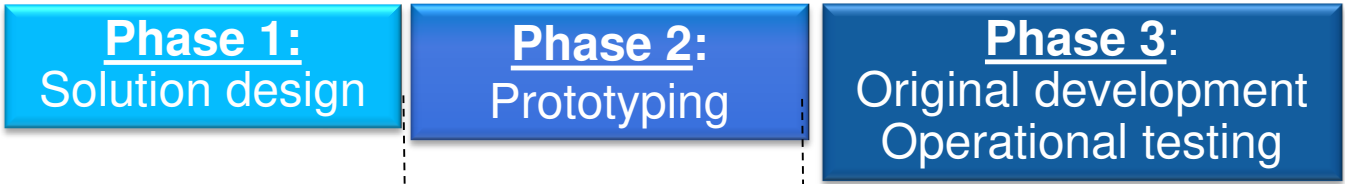
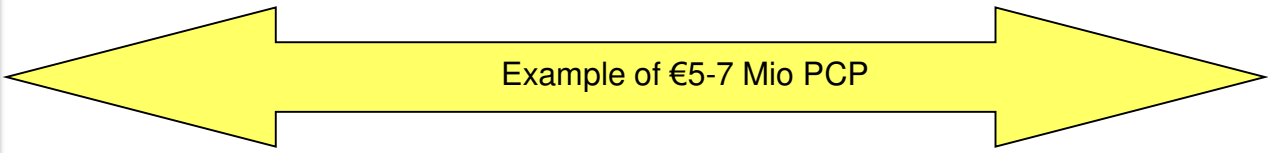



Example: 2. Budget split

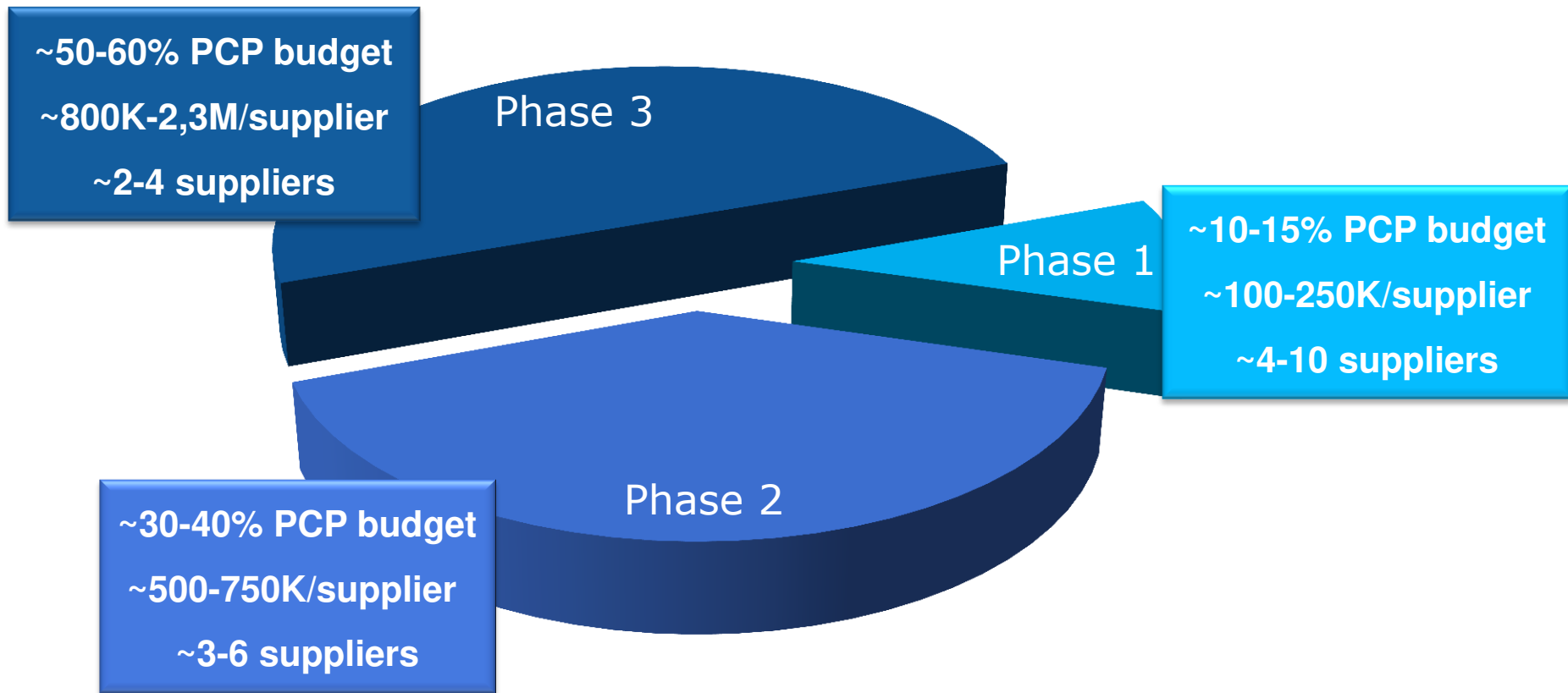



PcP projects



SMART@FIRE

<http://www.smartatfire.eu>



SILVER

[http://www.silverpcp.eu/.](http://www.silverpcp.eu/)



Concrete results (1/2)

- Shortening of time-to-market
- Min 20% cheaper products and higher product quality
- Removal of supplier lock-in -> 20% cost reduction
- Opening market to new players and stimulating cross-border company growth
- Creating lead markets
- Retaining lead market position
- Benefits on local economy



Concrete results (2/2)

Opening route-to-market for new players/SMEs

Joint procurement stimulates cross-border company growth

Relevance to universities & bringing scientific results to market

Encouraging commercialisation – budget efficiency

Creating growth and jobs in Europe



Concrete results

More info - PCP impact study- on:

<https://ec.europa.eu/digital-agenda/en/news/quantifying-impact-pcp-europe-study-smart2014-0009>



H2020 ICT-27-2017

System abilities, SME & benchmarking actions, safety certification

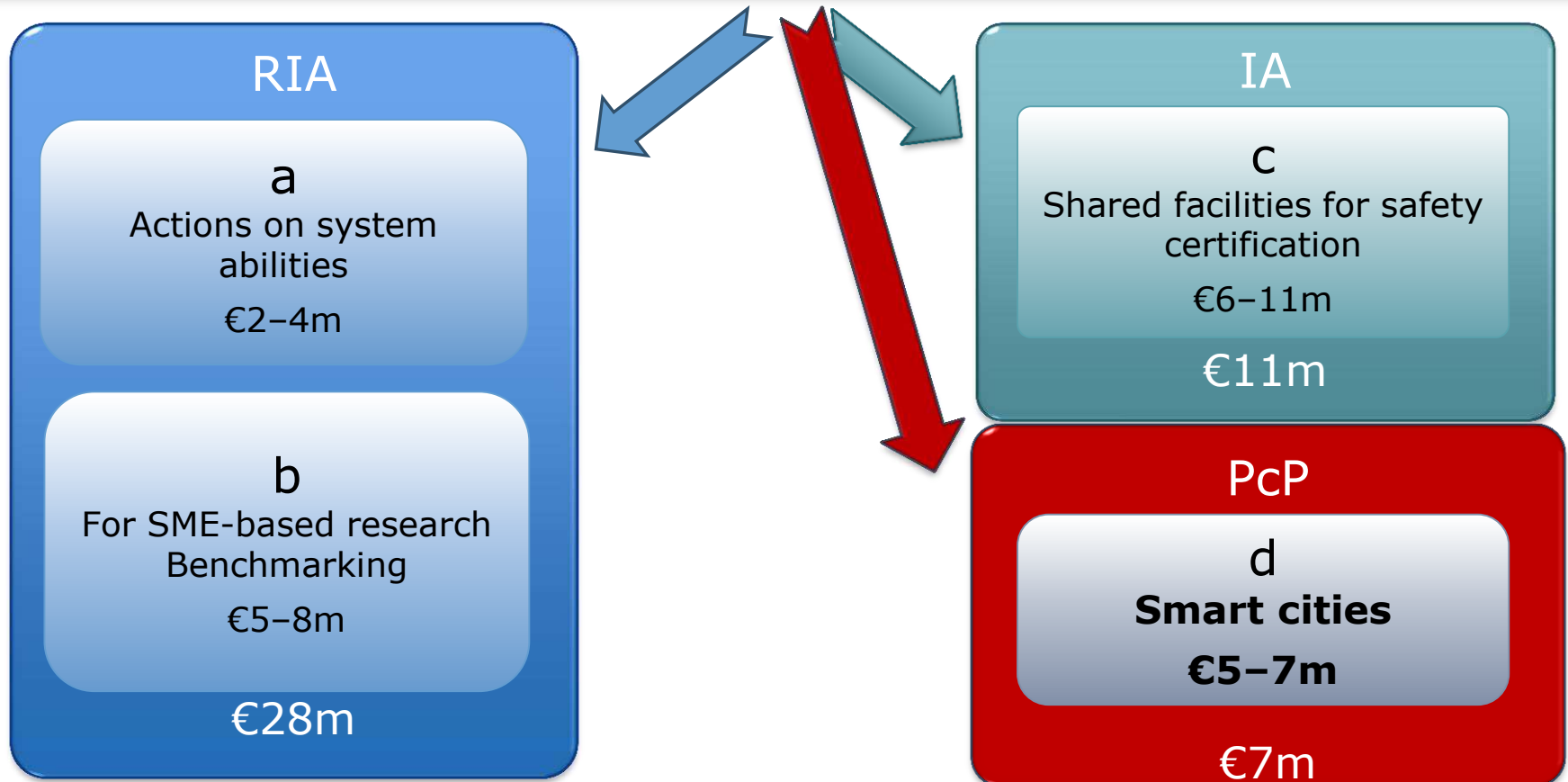



ICT-27.d PcP in Robotics

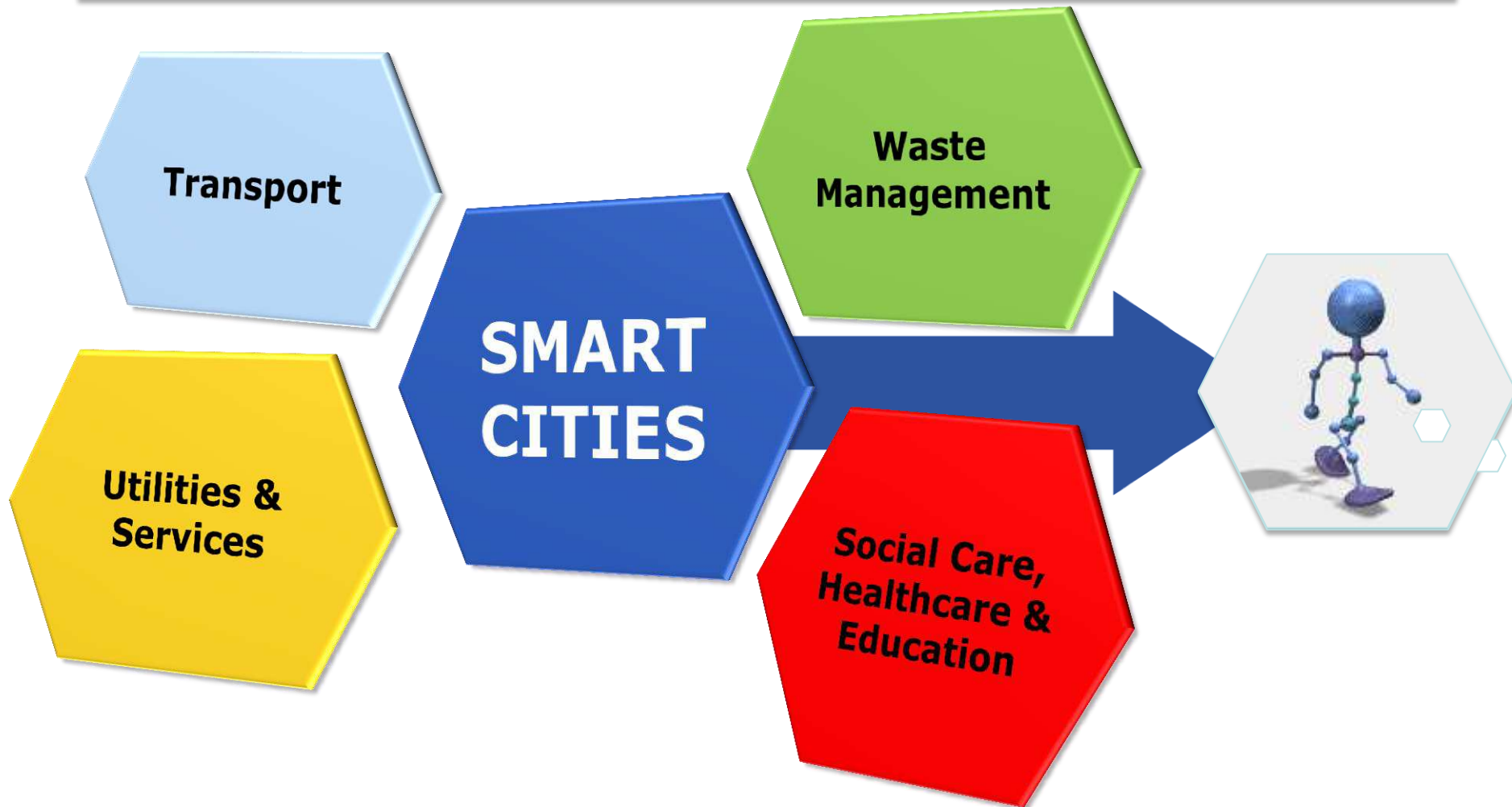



ICT-27.d PcP in Robotics

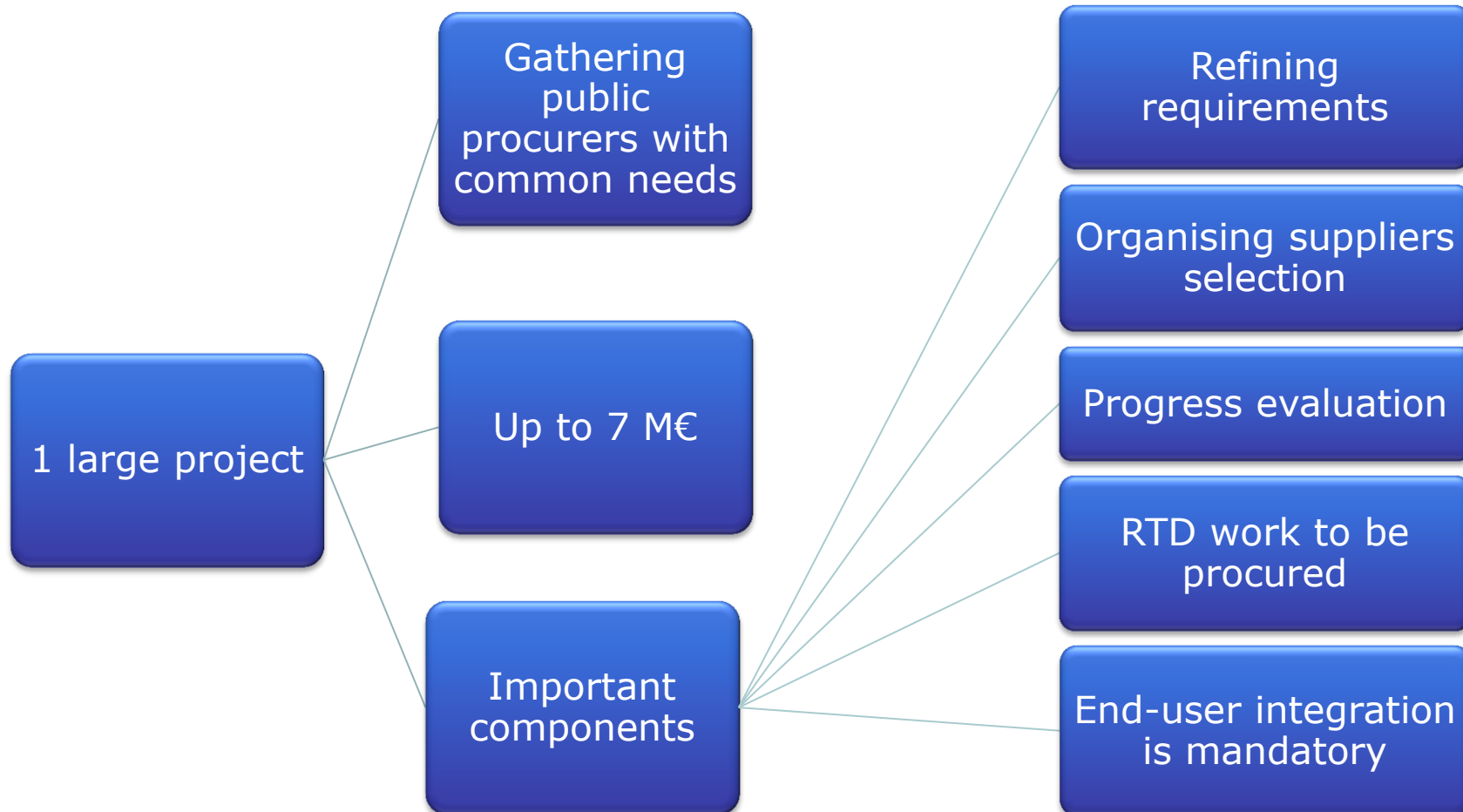



ICT-27.d PcP in Robotics

Proof-of-concept & validation of robotics technology

Encourage procurement of robotic technology

New market opportunities for robotics technology

Inroads for the defragmentation of the market

Potential elaboration of **standards** for the public procurement

**Expected
Impacts**

**Thank you for
your attention !**

Questions ?

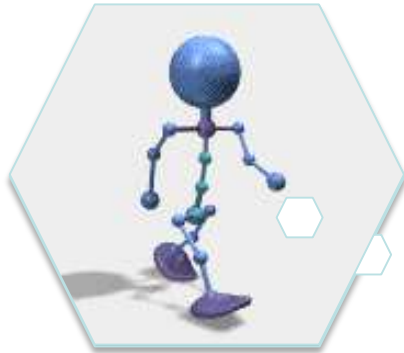

**SMART
CITIES**



Conditions

Public
acquisition
of research

Rules